

2052
MENFEZ KASA
0.280 kg/mt

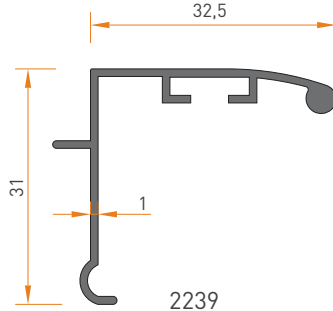

2239
MENFEZ KASA
0.255 kg/mt

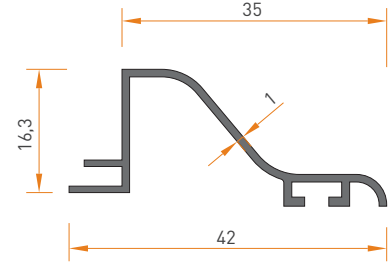

2086
MENFEZ KASA
0.215 kg/mt

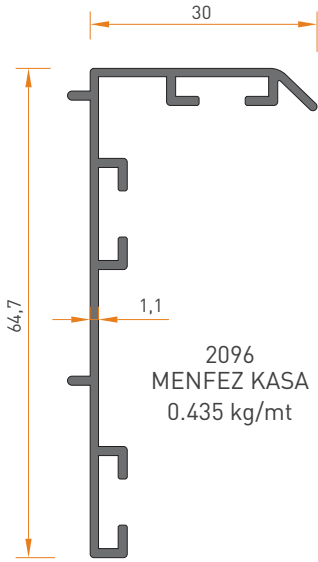

2096
MENFEZ KASA
0.435 kg/mt

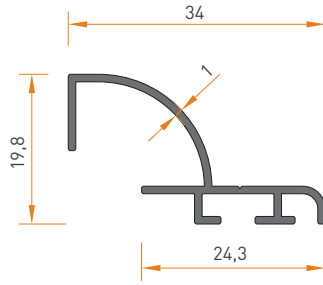

2246
MENFEZ KASA
0.210 kg/mt

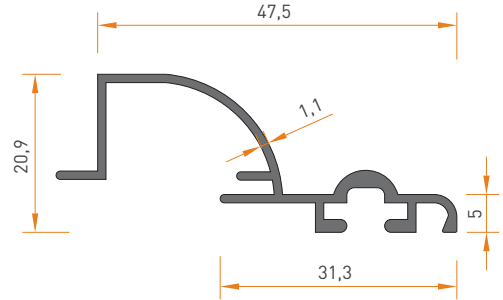

2243
MENFEZ KASA
0.345 kg/mt

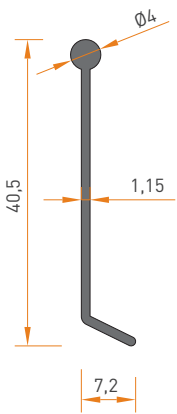

2053
MENFEZ YAPRAK
0.160 kg/mt

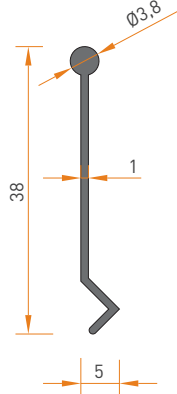

2084
MENFEZ YAPRAK
0.130 kg/mt

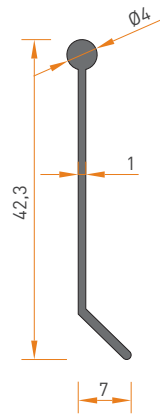

2240
MENFEZ YAPRAK
0.150 kg/mt

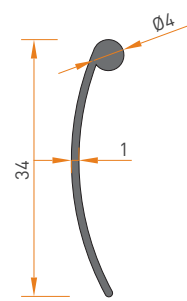

2237
MENFEZ YAPRAK
0.125 kg/mt

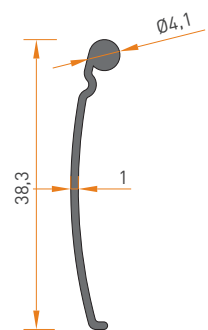

2042
MENFEZ YAPRAK
0.140 kg/mt

MENFEZ PROFİLLERİ

CULVERT PROFILES

PROFİL KESİT DETAYLARI

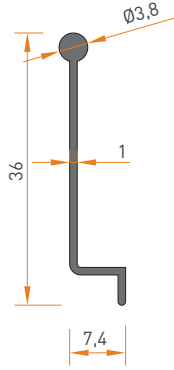
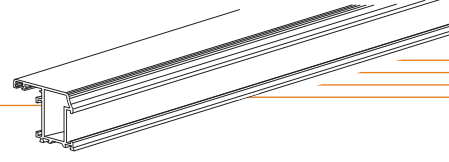

2085
MENFEZ YAPRAK
0.135 kg/mt

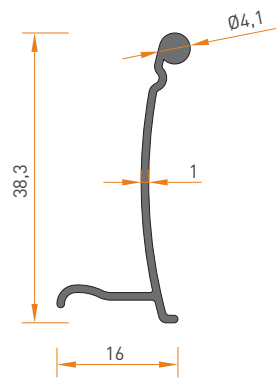

2044
MENFEZ YAPRAK
0.175 kg/mt

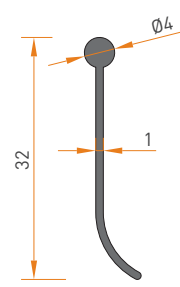

2245
MENFEZ YAPRAK
0.115 kg/mt

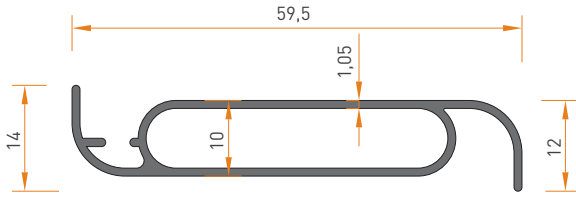

2434
PANJUR YAPRAK
0.390 kg/mt

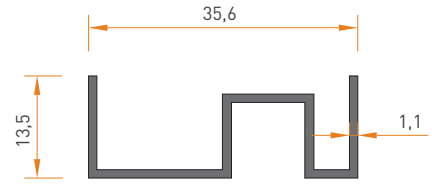

2435
PANJUR YAN
0.245 kg/mt

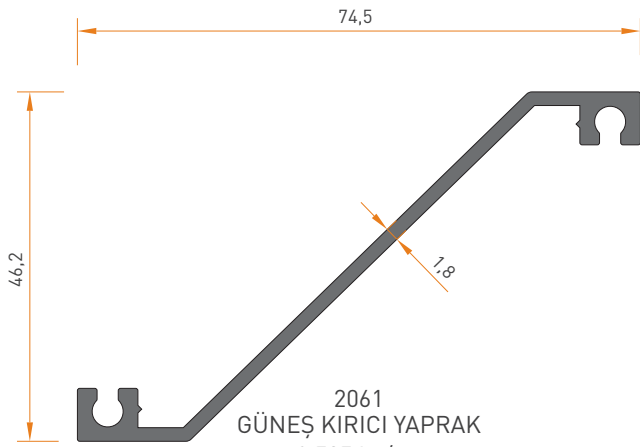

2061
GÜNEŞ KIRICI YAPRAK
0.585 kg/mt

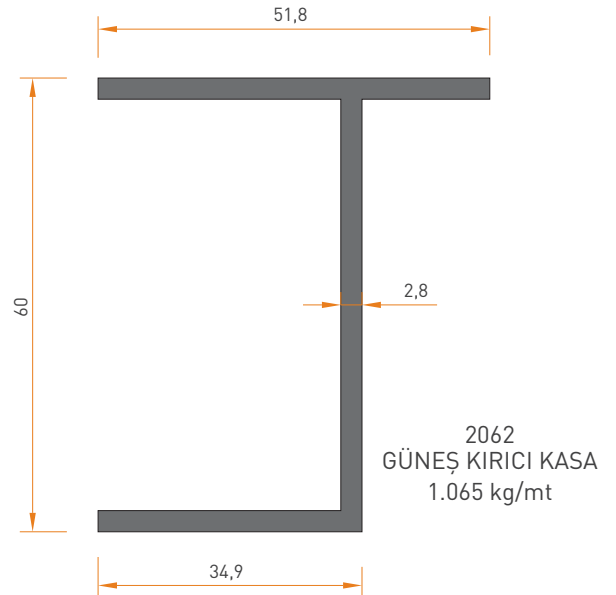

2062
GÜNEŞ KIRICI KASA
1.065 kg/mt

* Belirtilen ağırlıklar Pres Profil için teorik kilogramlardır.
* Boyalı Profillerde ağırlığa % 5 ilave edilmesi gereklidir.